

Livø-Further implementation of energy supply solutions-II

Birgitte Bak-Jensen
Pavani Ponnaganti

Livø island grid modeled in DigSILENT

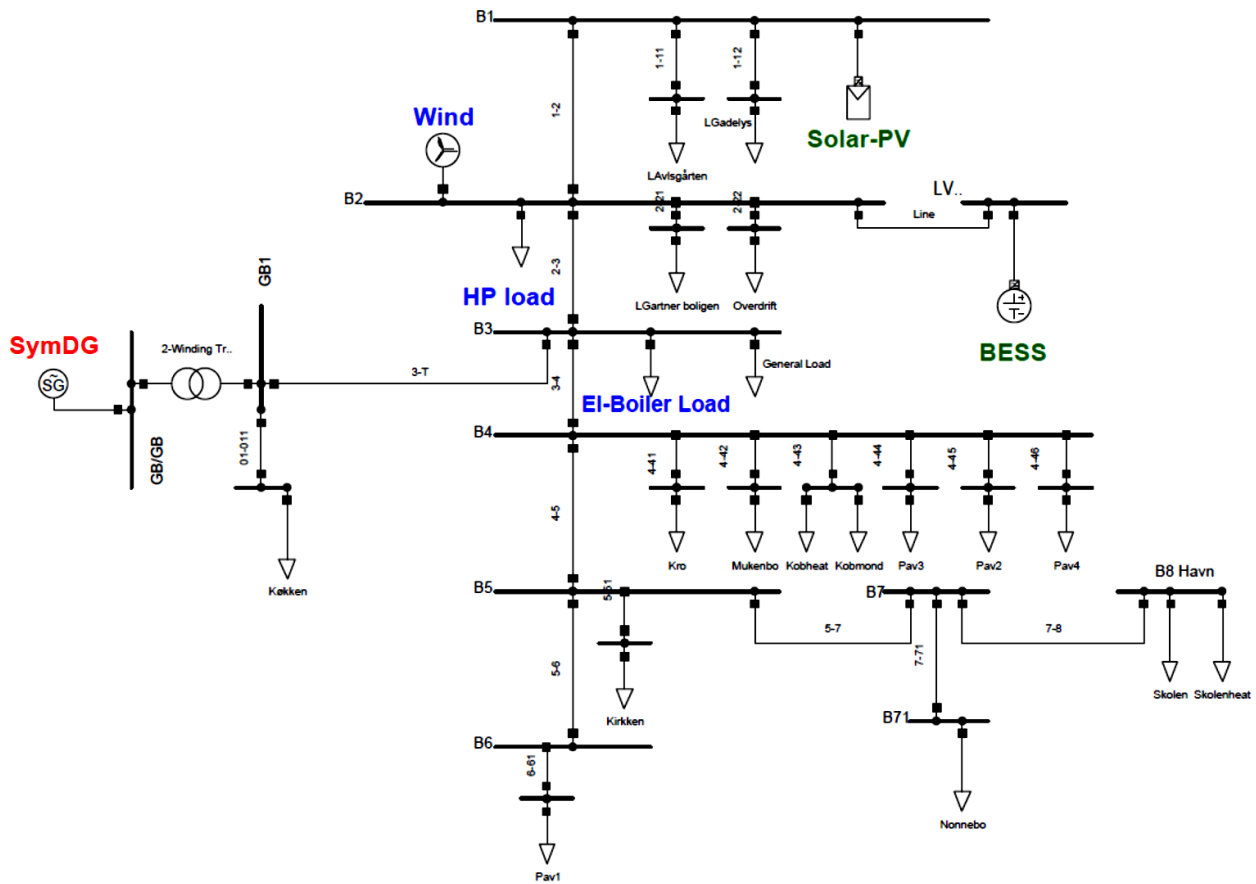

Figure 1b. DigSILENT model

The main objective of the current framework is to optimize the diesel fuel consumption with the help of effective asset management, thereby making the Island less dependent on conventional sources. The ratings/capacity of both the assets and main loads are given in Table I.

Table I: Assets in the Livø Island

Assets	Rating/Capacity
3* Diesel generators	36 kW each
PV-Solar	33 kWp rating
Wind generator	25 kW rated
Battery energy storage	5kW rating of 40 kWh battery capacity
Two Heat pumps	3.8 kW each
One electrical boiler	67.5 kW
New hot water storage tank (HWST)	30 m ³ volume
Wooden boiler	125 kW
HWST of wood boiler	8 m ³ volume
Oil boiler	580 kW
Dishwasher	9 kW
Køkken oven	24.8 kW

The production from solar PV and wind generator are prioritized for meeting the electrical demand and then diesel generator is employed. The excess energy available from both the solar and wind production after meeting the electrical demand is used to run Heat Pump (HP) or Electrical Boiler (EB) or store it in Battery Energy Storage System (BESS). The district heating (DH) plant consisting of a Wood boiler (WB) with dedicated heat storage tank is responsible for meeting the thermal demand on the Livø. The new HWST stores the heat from HP, EB and DG, thereby utilizing this heat whenever there is a gap exists between district heating output and thermal demand. If the available heat from both DH plant and LHWST is not enough to meet the thermal demand, then only Oil Boiler (OB) is employed. The electrical and thermal demands on the Island is seasonal and is mainly due to the tourists. The interesting fact of the Livø Island is that the electrical consumption is comparatively lesser than the thermal consumption.

II. Demand and Production on the island

The electrical and thermal demand profiles for the year 2017-2018 are as shown in Figs. 2 & 3. The production profiles of both the solar-PV and wind are as shown in Figs. 4 & 5. As it can be seen, both the demands are more predominant in spring and summer months, which witnesses large of number of tourists using facilities like charging their boats, heating, bathing, cooking etc.

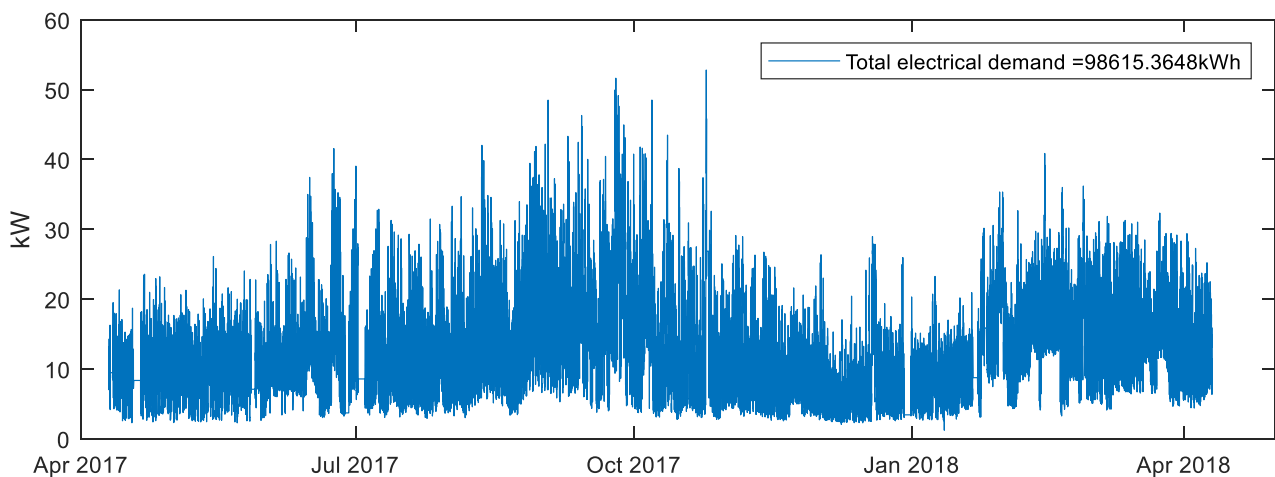

Figure 2: Electrical demand

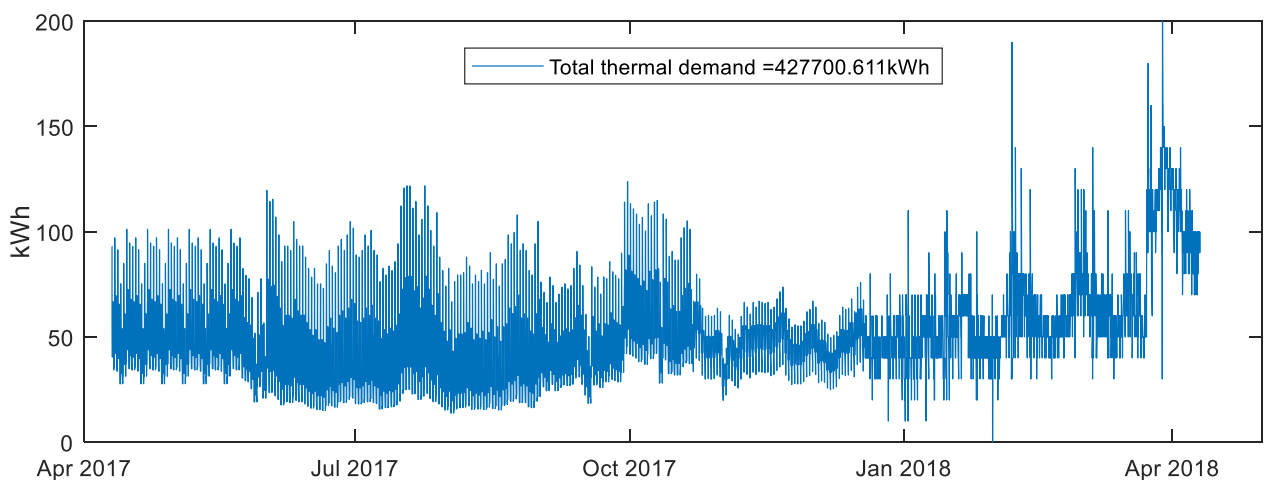

Figure 3: Thermal demand

During peak tourist seasons like spring and summer, the major share of the electrical consumption is 24.8 kW from oven and 9 kW from dishwasher that are present in the køkken. The other major loads can be ferry charging at the ferry harbor and local residential loads.

In addition, the DG must run more than $\frac{1}{4}$ th load, which is 11 kW for the stable operation. This condition is considered throughout this work. The thermal efficiency of the Diesel engine is 58%. If at full load the electrical efficiency of 32 % and the thermal efficiency of the engine is 58%, then the remaining 10% corresponds to the losses. The motivation is to increase the share of renewables in the Islands power consumption, the production from solar-PV and Wind is prioritized in meeting the electrical demand. If there exists electrical demand gap after met by the renewables, then the DG is operated. Results from two scenarios as follows are presented.

- **Base case scenario** is where only DG is present to meet both the Electrical and heat from DG, EB, WB, OB are used for meeting thermal demands.
- **Optimal case scenario** is where the main objective is to optimize the fuel (diesel) consumption in which assets includes, DG, Solar-PV, Wind, HP, EB, HWST, Wb and OB. The DG is operated to meet the electrical demand and if there is any gap exists between available thermal supply and actual thermal demand, after the operation of Solar, Wind, Wood boiler, Electric boiler and Heat pumps, thereby minimizing the (diesel) fuel consumption of the overall system.

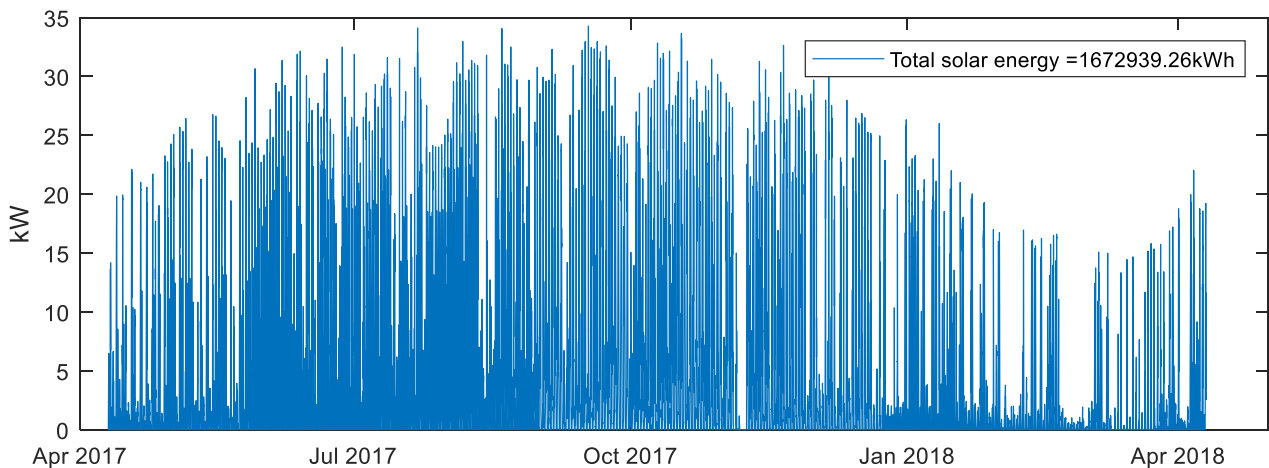

Figure 4: Solar production profile

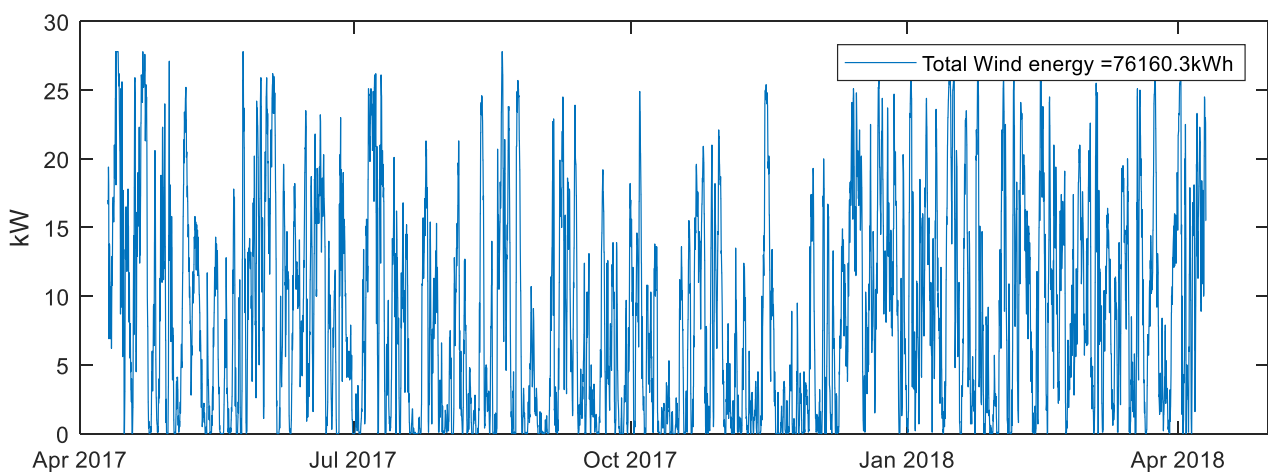

Figure 5: Wind production profile

Base case scenario

In this scenario, which was the original scenario of the Livø in the past without renewables, the assets include, 3 DG's, for meeting electrical demand and partially thermal demand. Electric boiler, Wood boiler and Oil boiler are responsible for meeting the major portion of the thermal demand. Figs 6 & 7 show the electrical and thermal outputs from DG. As it can be observed, the electrical output is higher than the actual electrical demand; this is because the DG has the constraint of operating at minimum 11 kW for its stability. This excess from DG is used towards firing Electric boiler and storing the heat in the HWST. Figs 8 & 9 show the thermal outputs from WB and OB towards meeting the thermal demand. It is to be noted that here the WB operation times considered are 8 hours during winter and 24 hours during summer period. The OB operation is continuous and operated whenever there is thermal demand that needs to be met.

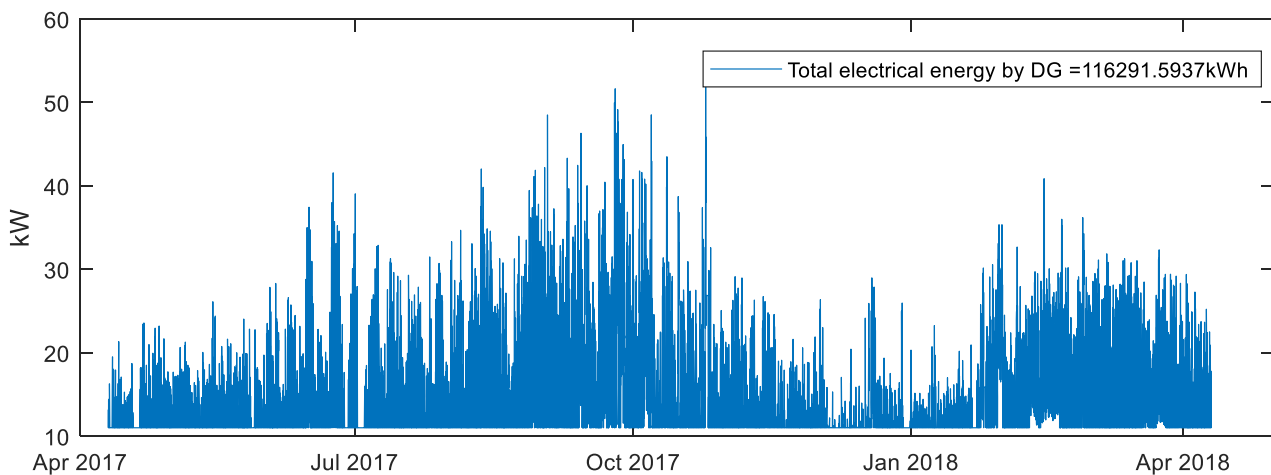

Figure 6: DG output to meet the Electrical demand for base case

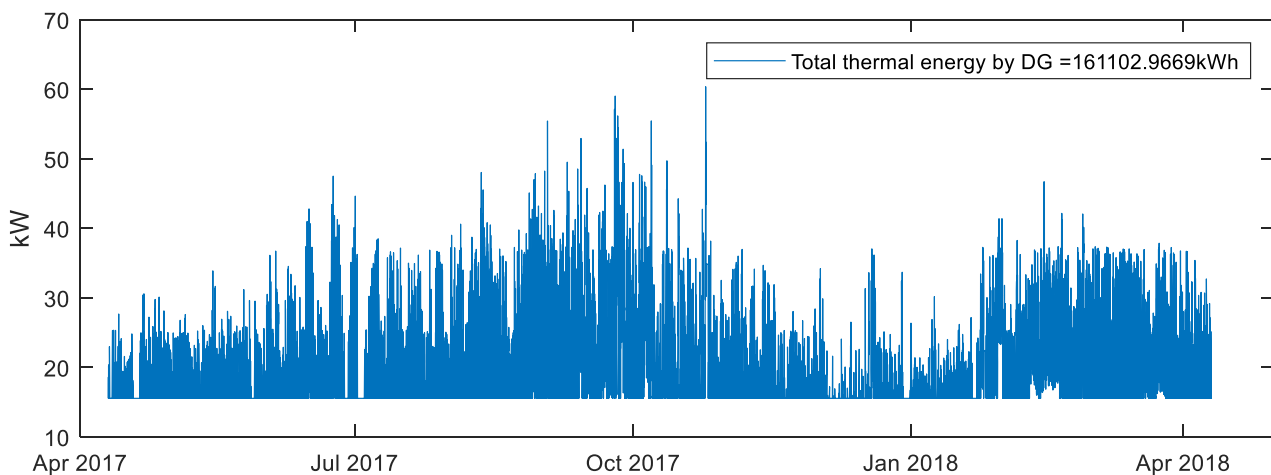

Figure 7: Heat produced by DG used to meet part of the Thermal demand for base case

It is to be noted that because of the constraint on DG for its stable operation, DG should generate a minimum of 11 kW even if there is lesser than 11 kW electrical demand. If roughly calculating, the current simulations are in minute time period, from the minimum production constraint, a total energy of $((365 \text{ days} * 24 \text{ hrs.} * 60 \text{ mins} * 11 \text{ kW}) / 60) \text{ kWh} = 96360 \text{ kWh}$ will be produced irrespective of the electrical demand.

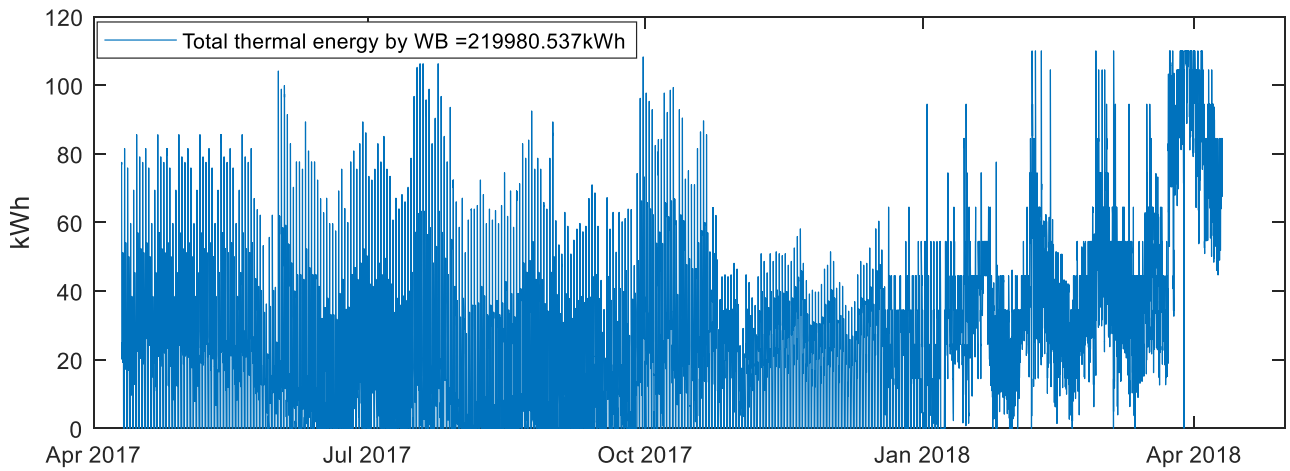

Figure 8: Heat produced by WB used to meet the Thermal demand for base case

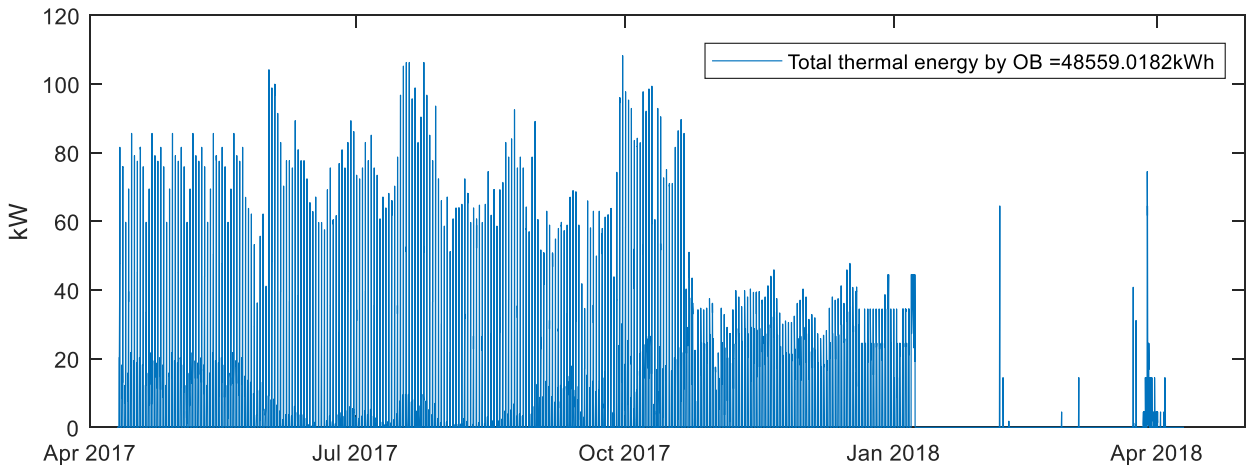

Figure 9: Thermal output from Oil Boiler for base case

The base case results clearly show that DG is responsible for meeting the total electrical demand. Whenever DG is producing 11 kW in which the electrical demand is less than that of 11 kW, this excess is used to fire electric boiler and the heat is stored in the HWST. Also, the heat from the DG is also stored in the HWST. For meeting the thermal demand, it is inevitable that Oil boiler needs to be run, if the available heat from DG, HWST and Wood boiler are not sufficient, which is clear from Fig. 9 showing the thermal output from OB to meet the deficit thermal demand. The individual shares of electrical and thermal demands from various assets for the base case scenario are as given in Table II.

Table II: Electrical and thermal energy shares of various sources

Quantity	kWh	Shares
Total Electrical demand	98615.36	100%
DG El-prod	116291.59	117.9%
Total thermal demand	427700.61	100%
DG+EB heat prod	161102.96	37.66%
WB heat prod	219980.53	51.43%
OB heat prod	48559.018	11.3%
Total heat prod	429644.97	

Optimal case scenario:

The set-up of HWST is as shown in Fig. 10 (a) with heat connection from DG, EB and HP's. In addition, the district heating system with WB and its tank and finally OB. The priority operation of the smart loads is given in the Fig. 10 (b). It is to be noted that there is a time gap of 15 mins between ON and OFF status of the HP and another 15 mins for the HP to reach to its maximum output.

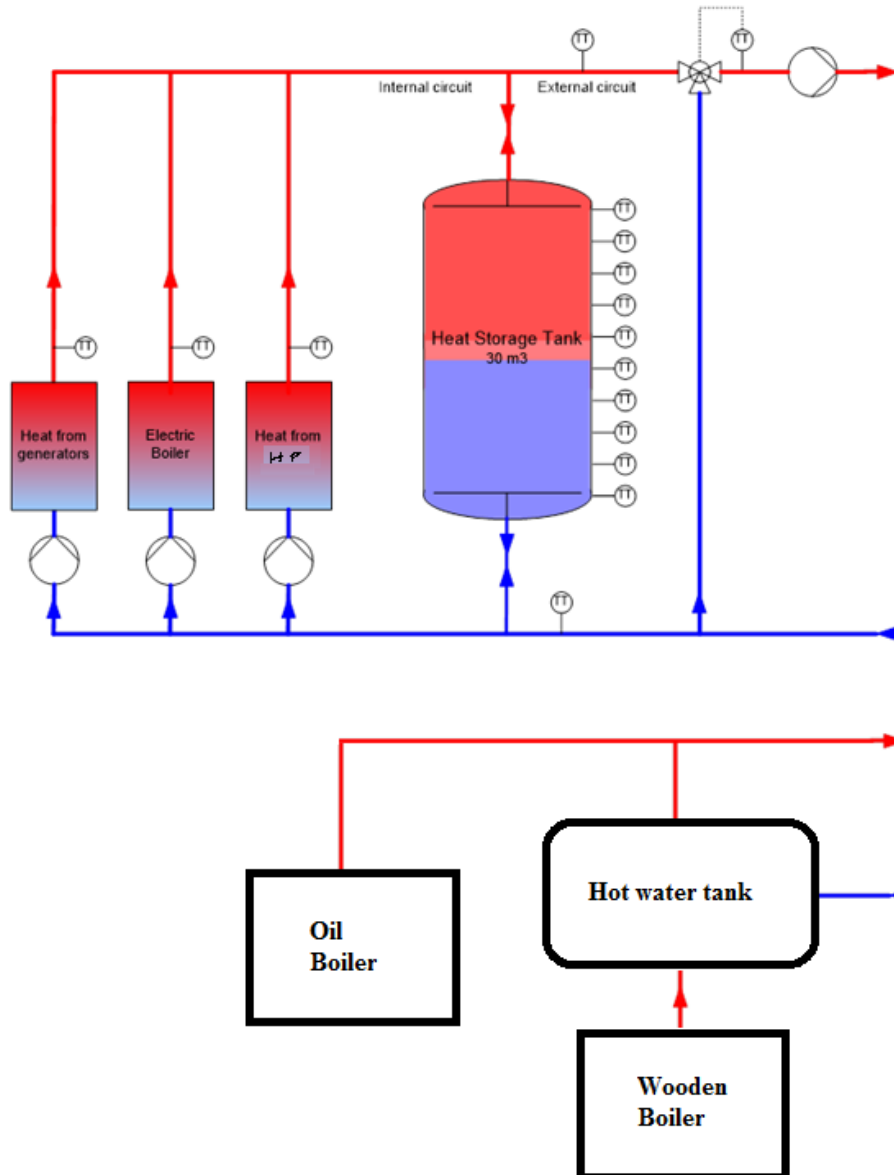

Figure 10 (a): HWST set-up

For maintaining 75 deg inside the hot water storage tank, the total energy capacity of the HWST with dimension 30000 liters volume, return temperature to be 40 deg and specific heat of water (4.2 kJ/kg C) is $4.2 \cdot (75-40) \cdot 30000 / 3600 = 1225$ kWh. In the same way the maximum energy that can be stored inside the storage tank associated with the wooden boiler is (4.2 kJ/kg C) is $4.2 \cdot (75-40) \cdot 8000 / 3600 = 326.67$ kWh. The overall working algorithm is given in a flow chart as shown in Fig. 10 (b).

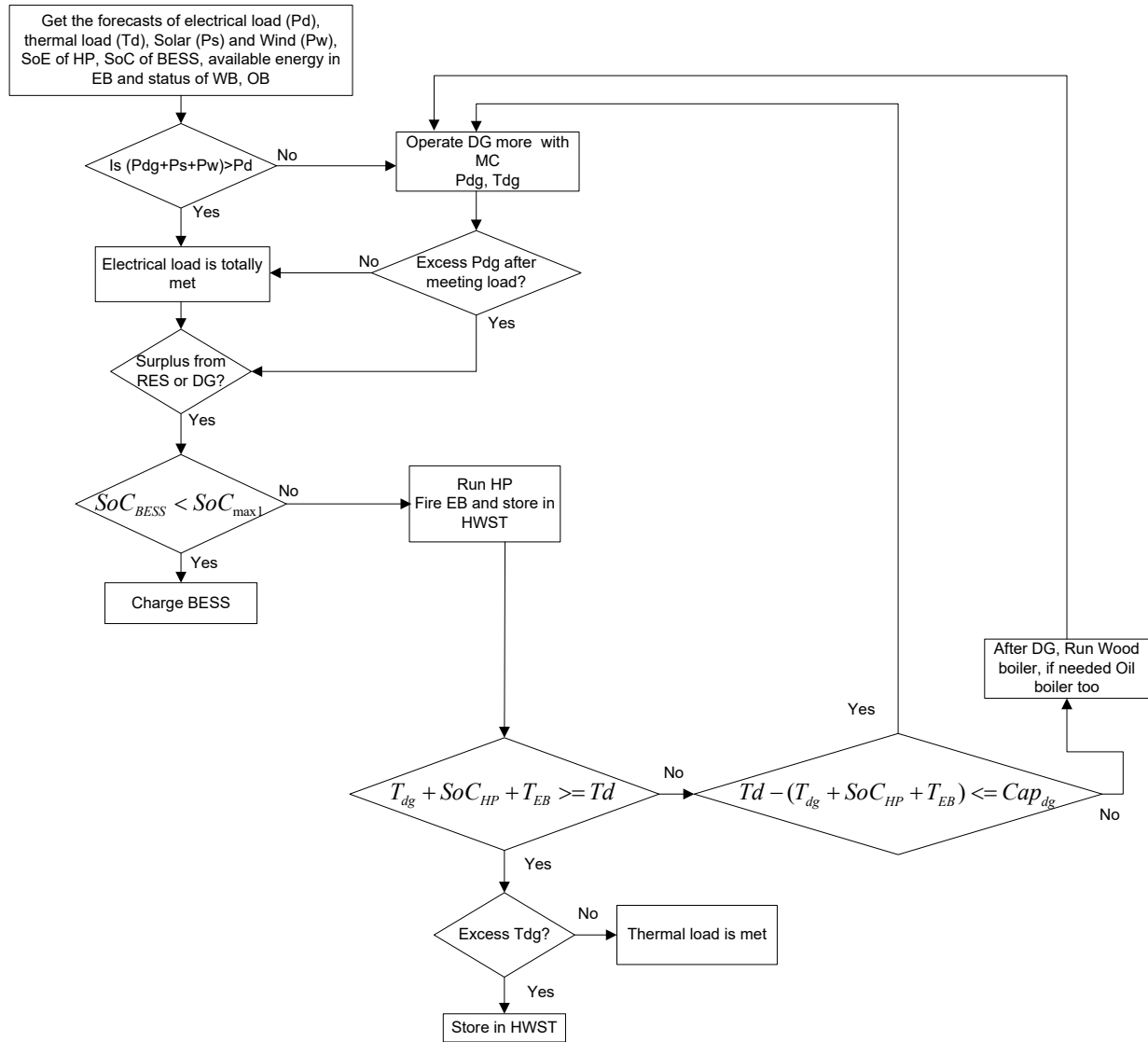

Figure 10 (b): Flowchart depicting the proposed working principle of the Livø grid.

The hierarchy for the operation of the smart loads is as given the following algorithm,

1. *The main objective is to reduce the diesel consumption.*
2. *Once the electrical load is met, the algorithm gathers the information about*
 - i. *Available energy in Wood boiler tank.*
 - ii. *Available excess from renewables*
 - iii. *Any excess from DG (due to minimum 11 kW production constraint)*
 - iv. *Available energy in HWST.*
 - v. *Available energy in BESS*
 - vi. *Thermal demand that needs to be met.*
3. *If there exists gap between available heat and the thermal demand after energy from Wood boiler tank and HWST is not enough then,*
 - i. *if excess is there from renewables,*
 - *Heat pump is prioritized to meet the gap,*
 - *If HP cannot fill the gap, then EB is operated else run Oil boiler.*

- If the heat from HP and EB meet the thermal demand gap, the remaining excess will be used to charge the battery.
- ii. If there is no available excess,
- Directly run the Oil boiler to fill the gap,
 - Else, re-run the DG as a last option.

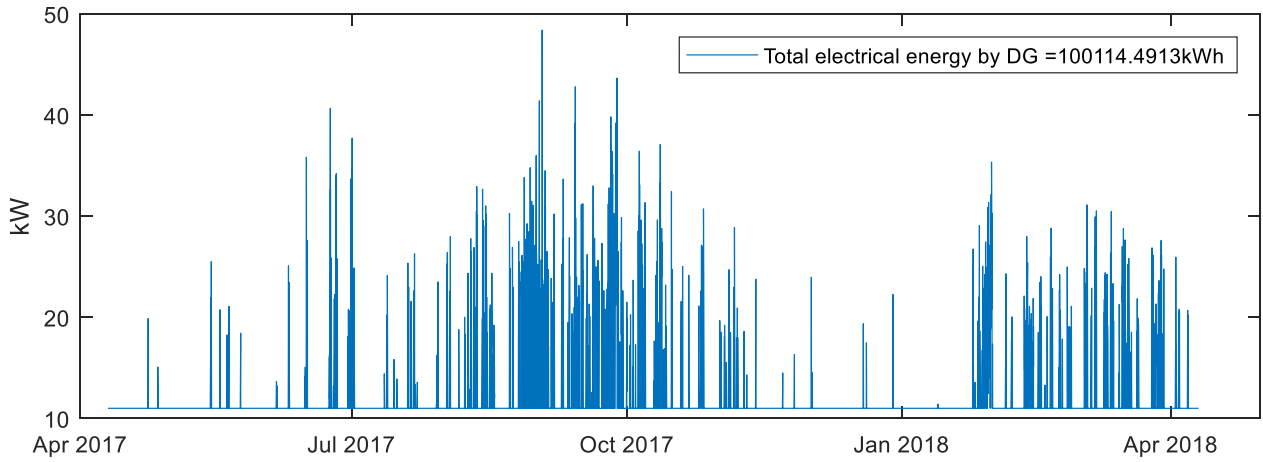

Figure 11: DG output to meet Electrical Demand for optimal case

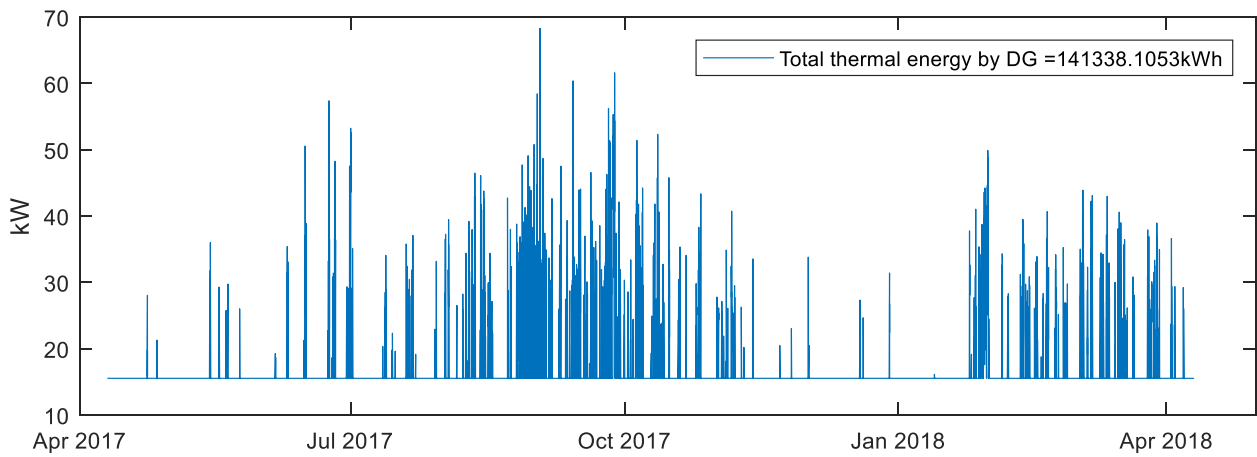

Figure 12: DG output to meet Thermal Demand for optimal case

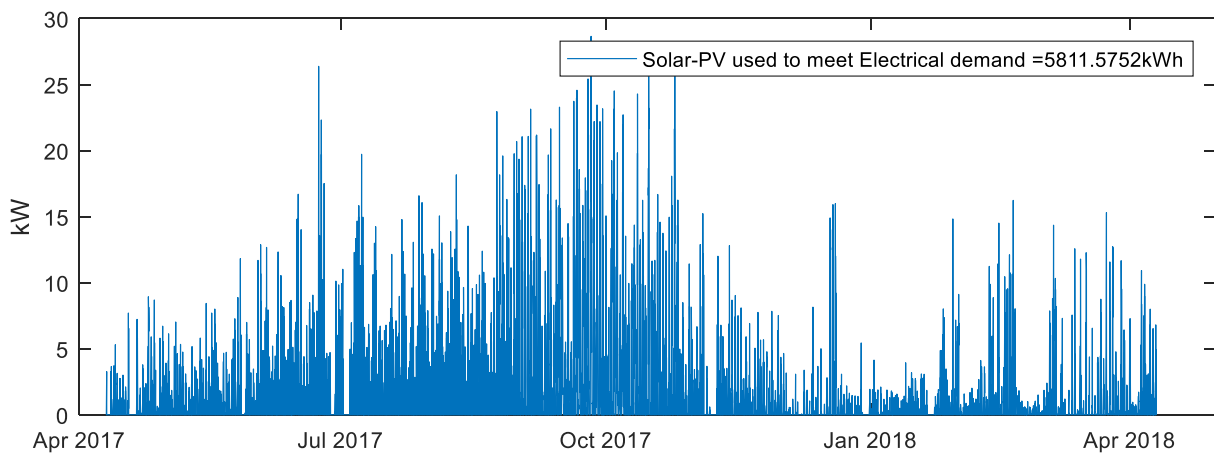

Figure 13: Solar production used to meet Electrical demand for optimal case

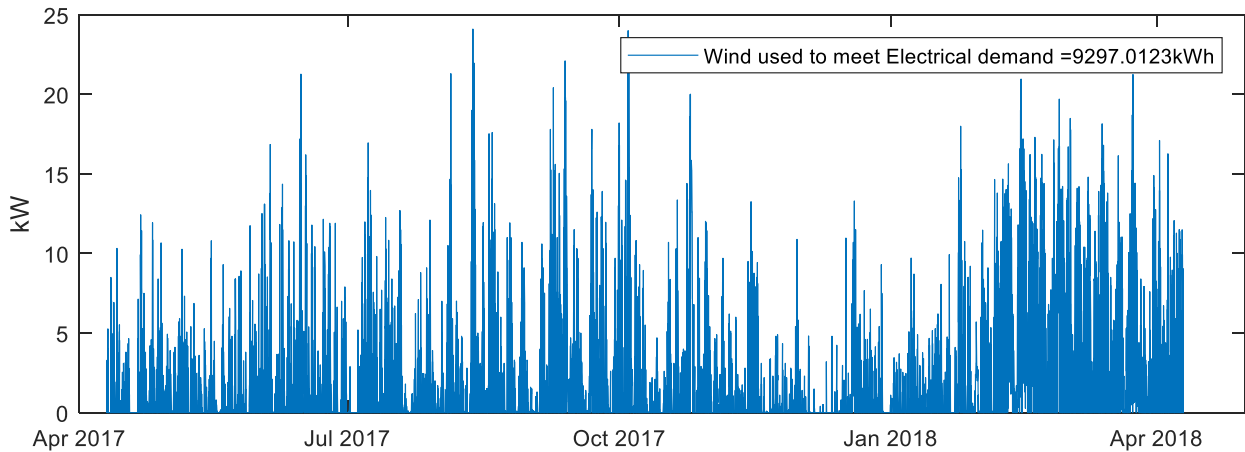

Figure 14: Wind production used to meet Electrical Demand for optimal case

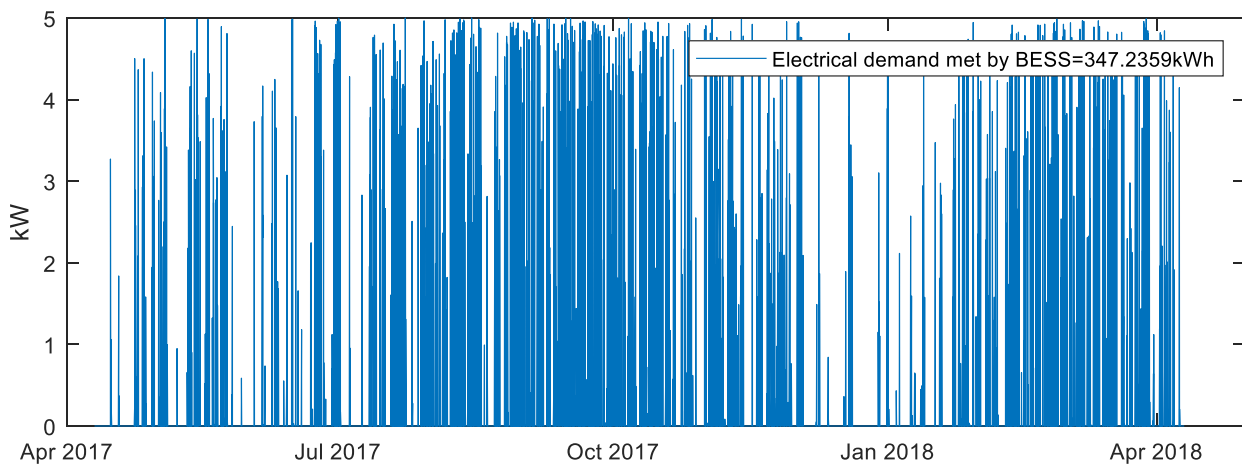

Figure 15: Electrical demand met by BESS

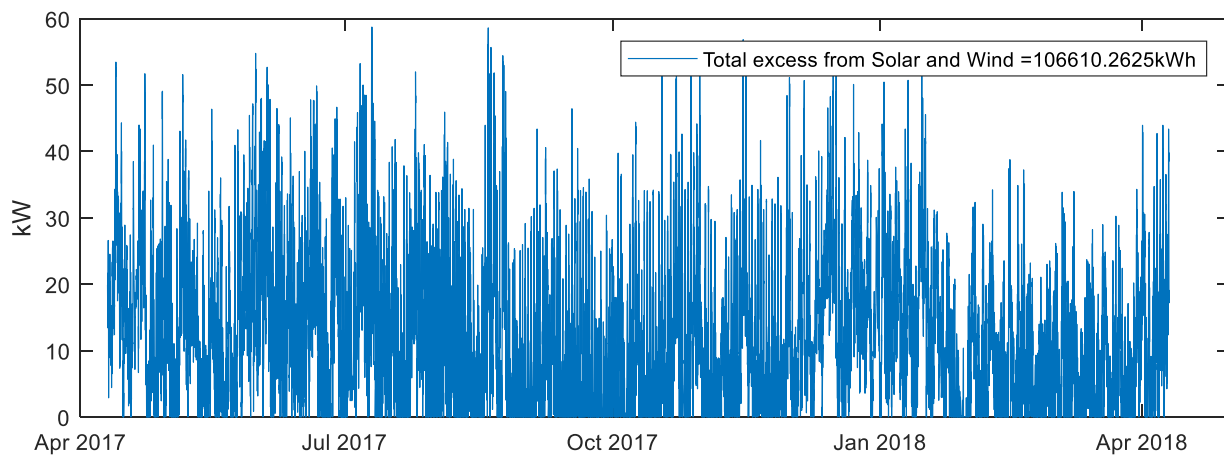

Figure 16: Excess production from Solar and Wind

From Figs. 13, 14 & 15, the total electrical energy utilized from Solar-PV, wind and BESS, respectively, towards meeting electrical demand is $(5811.57+9297.01+347.23) = 15455.81$ kWh, whereas from Fig. 11, the share from DG towards meeting the electrical demand is 100114.49 kWh. The total electrical demand is 9.8615×10^4 . It can be observed that the actual electrical demand is lower than the energy that is being produced. It is because, irrespective of demand level the DG produces 11 kW for meeting stability constraint.

This extra electrical energy from DG is utilized towards running either Heat pumps or Electrical boiler by storing the produced heat from them into HWST, thereby used for meeting the thermal demand.

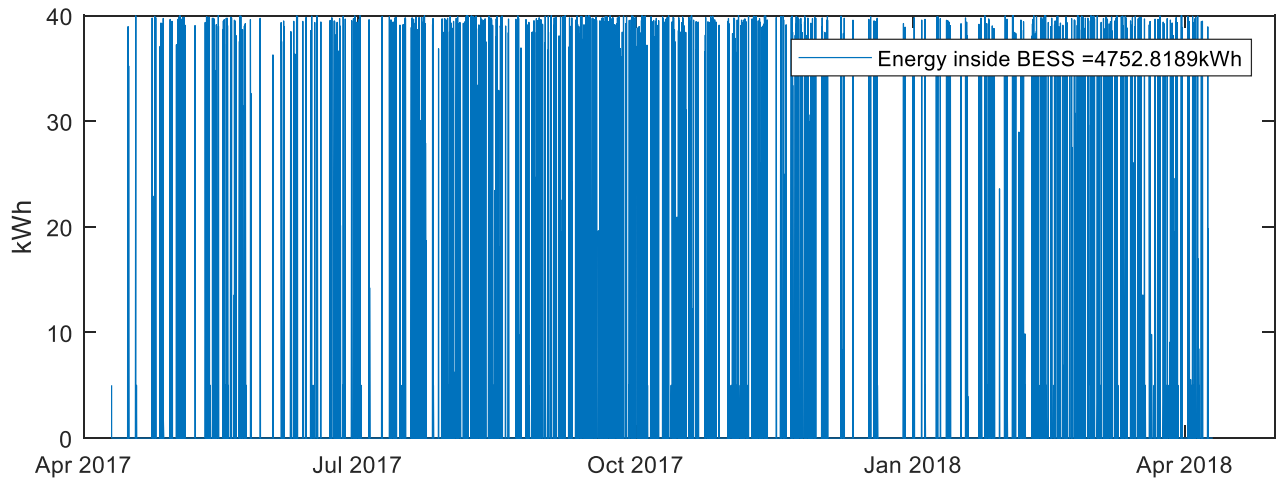

Figure 17: Energy level inside the BESS of capacity 40 kWh

Figure 16 shows the excess energy available from both the solar-PV and wind productions, which is intelligently utilized for running heat pumps, Electrical boiler and for charging BESS. The heat from HP and EB is stored in HWST, whereas the electrical energy in BESS as shown in Figure 17, is to reduce the production of diesel generator. It is to be noted that the ramp rate is not considered in the BESS operation. The excess energy from renewables is utilized in such a way that, HP and EB are run to meet the gap between available heat and thermal demand needs to be met. Then the remaining excess is used to charge the BESS. The individual shares of electrical and thermal demands from various assets for the base case scenario are as given in Table III.

Table III: Electrical and thermal energy shares of various sources

Quantity	kWh	Shares
Total Electrical demand	98615.36	100%
DG El-prod	100114.49	84.69%
Solar prod	5811.575	5.89%
Wind prod	9297.01	9.42%
Excess from renewables	106610.26	
Energy in BESS	4752.3667	
Total thermal demand	427700.61	100%
DG heat output	141338.10	33.04%
HWST heat output	247462.51	57.85%
WB heat output	27697	6.47%
OB heat output	11202.73	2.64%
Total heat prod	427704.75	

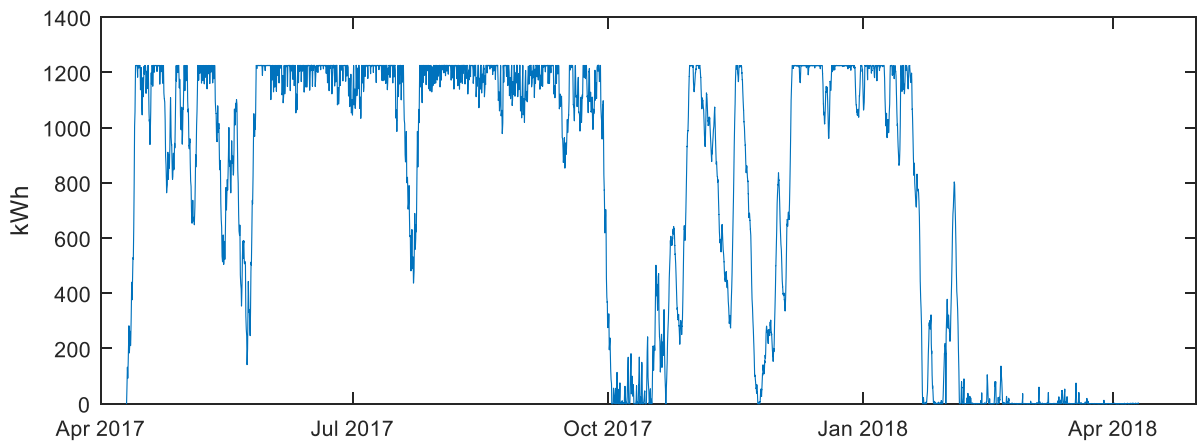

Figure 18: Charging/Discharging of HWST (Heat from DG+HP+EB) for the optimal case.

Fig. 18 shows the charging of the tank from heat from DG, HP and EB and discharging to meet the thermal demand. The heat demand met by the HWST is shown in Figure 18. As it can be observed that most of the thermal demand on the Livø island is been met by the HWST in the optimal fuel consumption case. Figures 20 & 21 show the heat from WB and OB. Depending upon the energy level inside the HWST, where the energy inside the tank is very low in the months of Oct 2017 and Feb-Apr 2018, due to which the thermal demand is met by WB and OB. At the beginning WB produced heat to meet the thermal demand, as in the beginning of the simulations, the HWST is considered empty. The electrical boiler and heat pump are operated from the excess energy from the renewables.

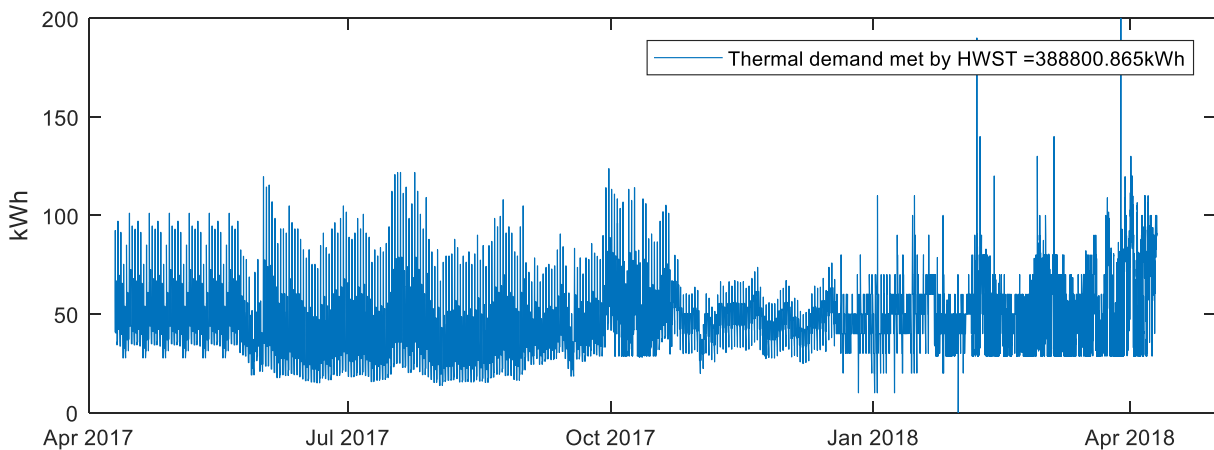

Figure 19: Thermal demand met by HWST for optimal case

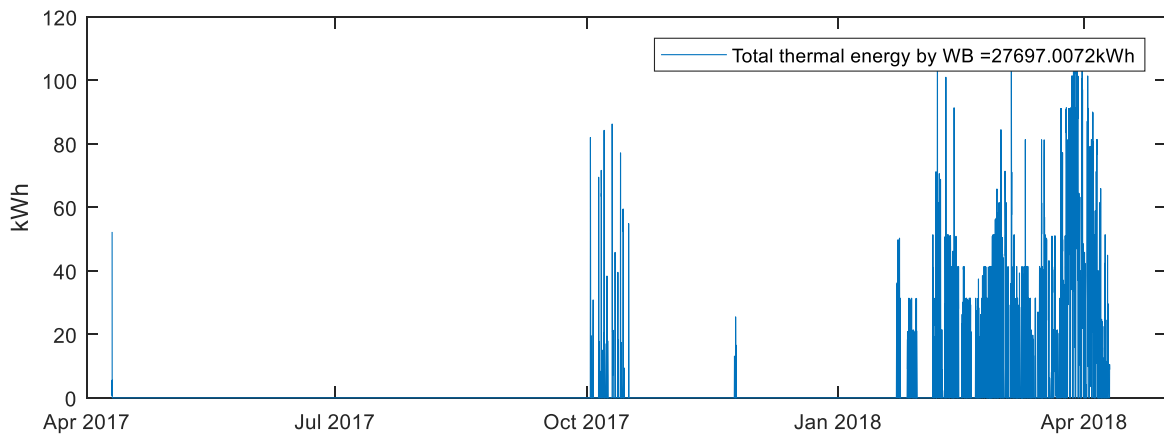

Figure 20: Thermal output from Wood boiler for optimal case

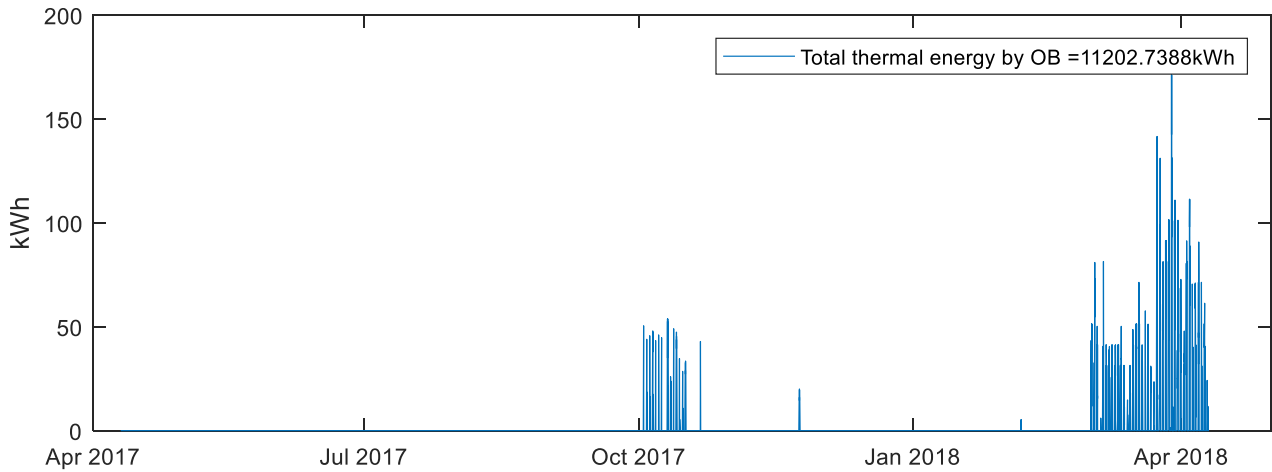

Figure 21: Thermal output from Oil boiler for optimal case

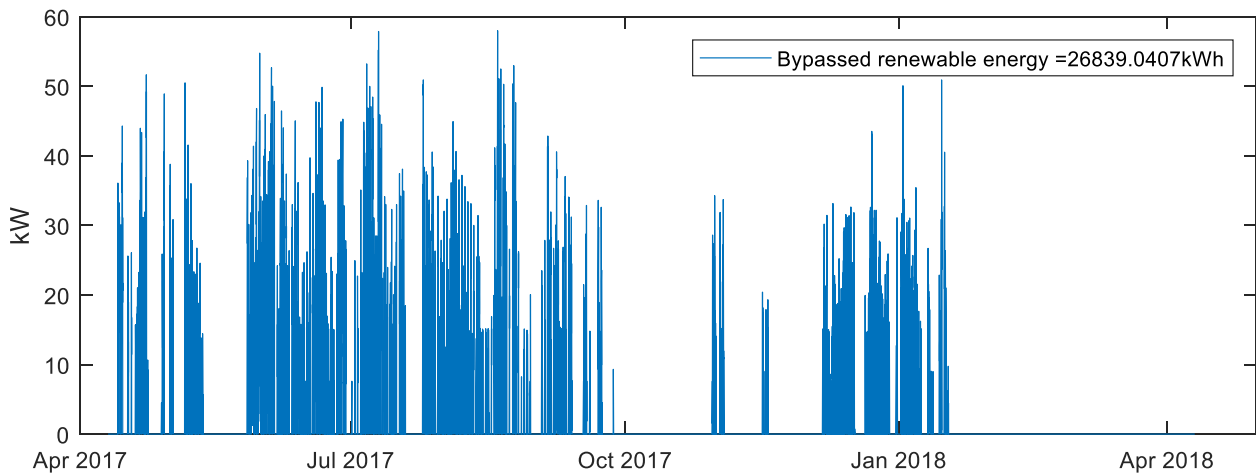

Figure 22: Renewable energy that is bypassed from the system

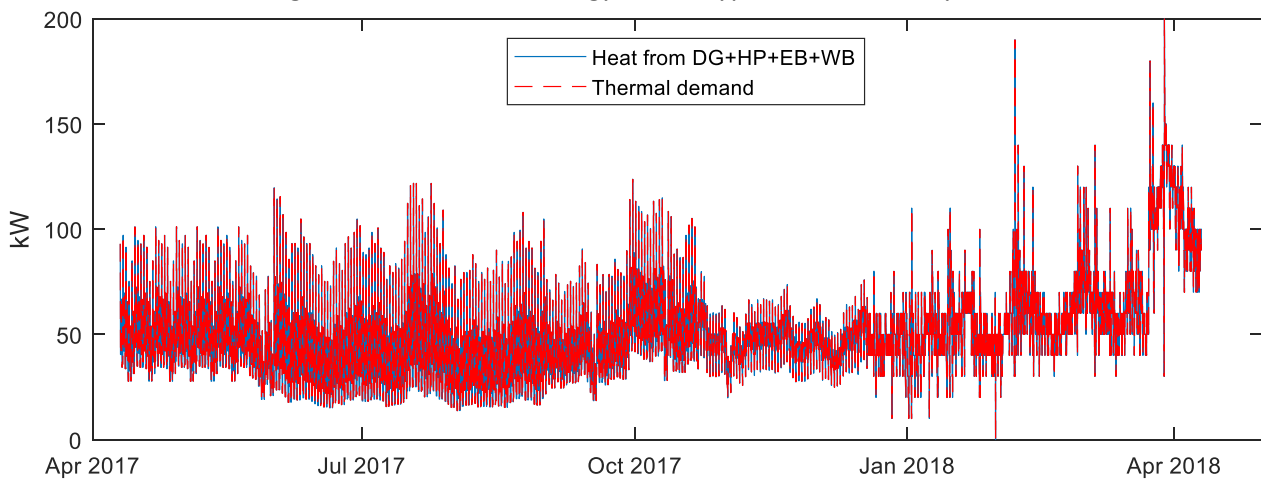

Figure 23: Total thermal power produced Vs Total thermal demand for both base and optimal cases

It is interesting to observe Figure 22 showing the renewable power that is bypassed from the system. This depicts that the system with the current operating conditions could not accommodate the renewable production, leading to the shutting down in the priority of Wind turbine and then Solar-PV. The actual heat demand and produced heat is shown in Figure 23.

Table IV : Diesel consumption in kWh/liters/galons for considered cases

Fuel input (DG+OB)	kWh	Galons	Liters
Base case	378800	9407.3	35610
Optimal case	295140	7330.1	27745

Table V: Seasonal fuel consumption of DG for base case and optimal case

Seasons	Fuel input in Base case (kWh)		Fuel input of DG in optimal case (kWh)	
	DG	OB	DG	OB
Year	334480	44317	282963	12176.8
Spring	49735	10552	41484.5	2681.2
Summer	52595	7879.7	48343	--
Fall	63621	4660.9	51927	--
Winter	168530	21224	147370	9479.4

The total diesel consumption for both base and optimal cases is given in Table IV. Table V gives the fuel consumption by DG and OB for both the base and optimal cases for the whole year and for various seasons too. It is very clear that there is considerable reduction in diesel consumption for optimal case when compared to base case. The DG is producing 11 kW all the time and if the load demand is more than 11 kW, then the production from solar-PV and wind is used to meet the rest of the electrical demand. Even if the available energy is not enough then the BESS is employed. If there exists excess from renewables, then the HP and EB are operated, thereby storing their heat in the HWST. If the HWST and BESS are full by their maximum energy capacity, then the excess needs to be bypassed. Here in the current scenario, primary frequency response is done by BESS. The DG is made responsible for secondary frequency response, which minimizes the impact of quick start on the diesel generators. At times when there is not enough capacity in BESS, then inevitable the primary frequency response is handled by DG.

Dynamic simulations

In addition to the above simulations, dynamic simulations are also carried out to analyze the frequency of the system for the optimal case. Figure 24 (a) shows the frequency of the grid with DG, renewables and BESS.

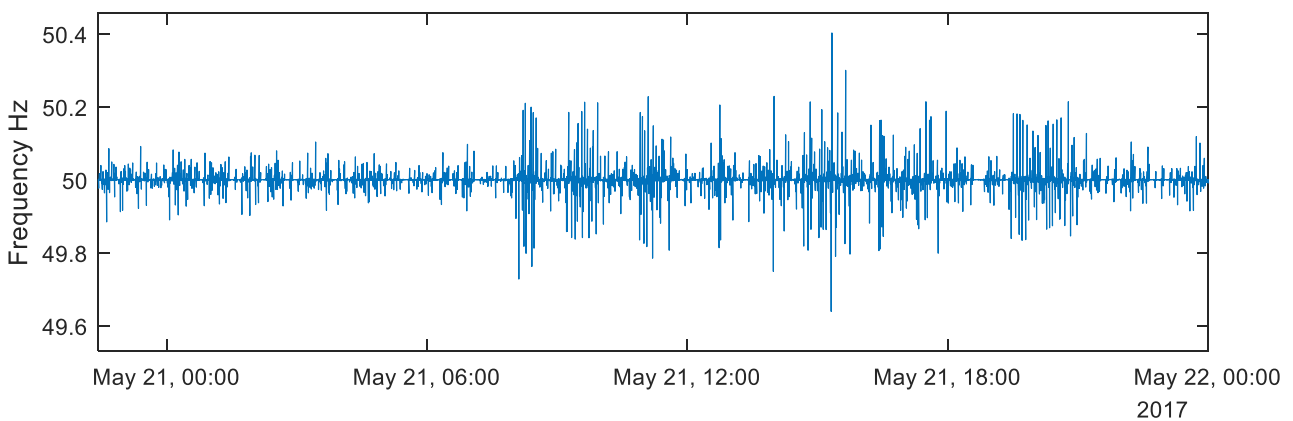

Figure 24 (a): System frequency from May 21

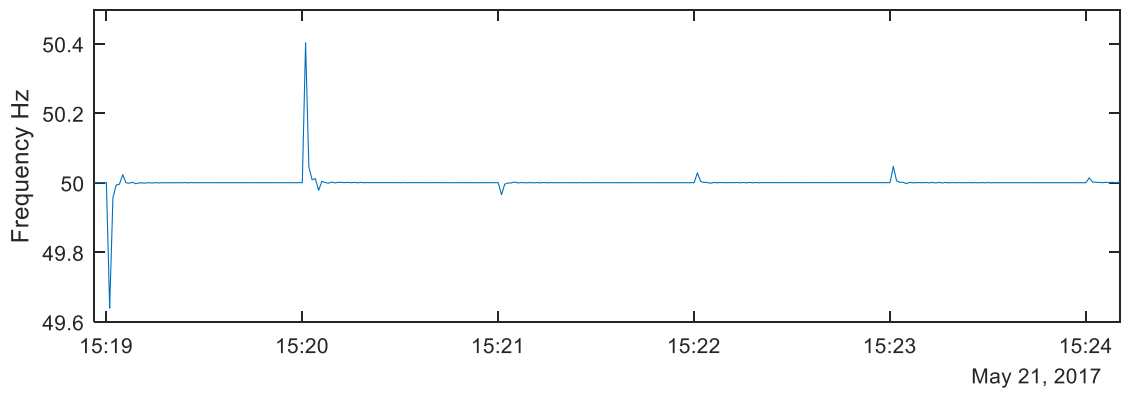

Figure 24 (b) Frequency on May 21, 2017

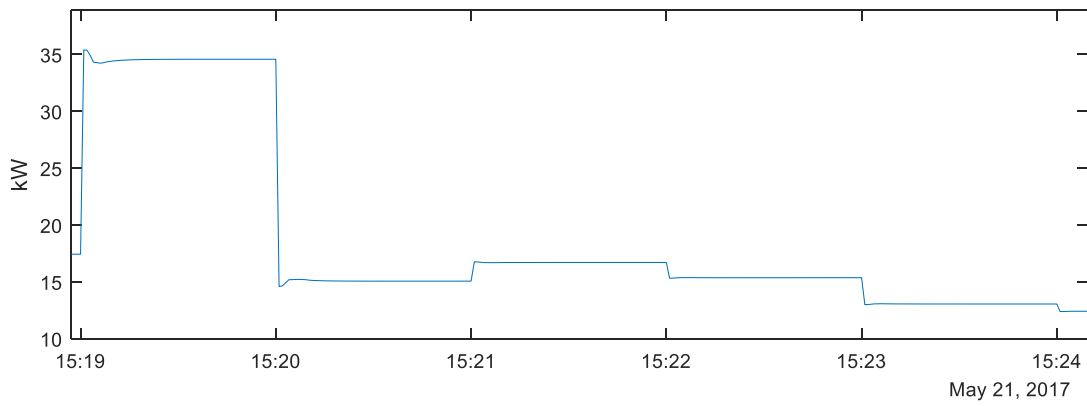

Figure 24 (c): Electrical demand on May 21, 2017

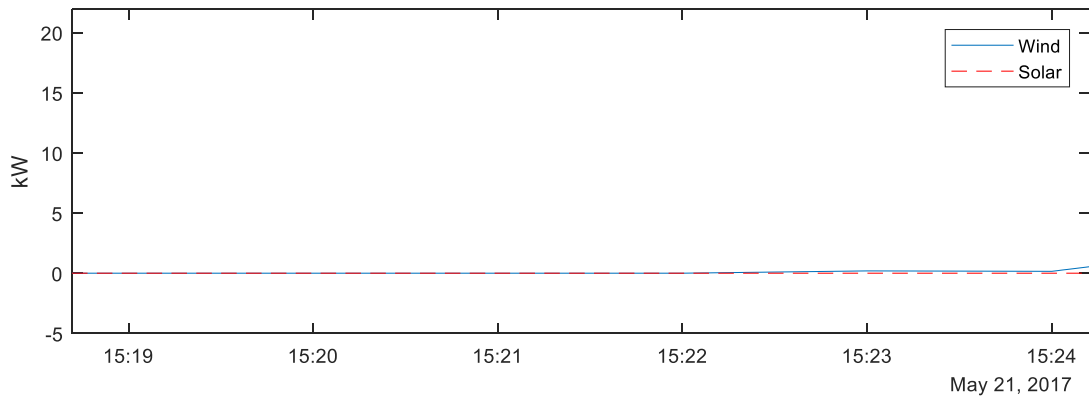

Figure 24 (d): Wind and Solar on May 21, 2017

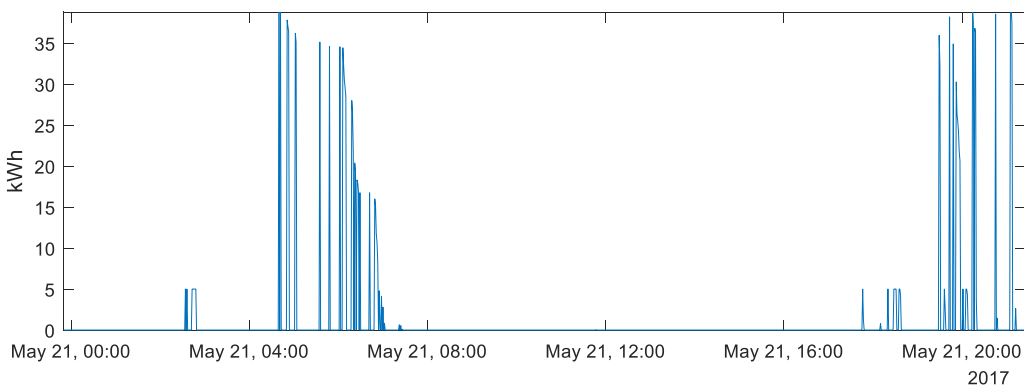

Figure 24 (e): Energy inside BESS on May 21, 2017

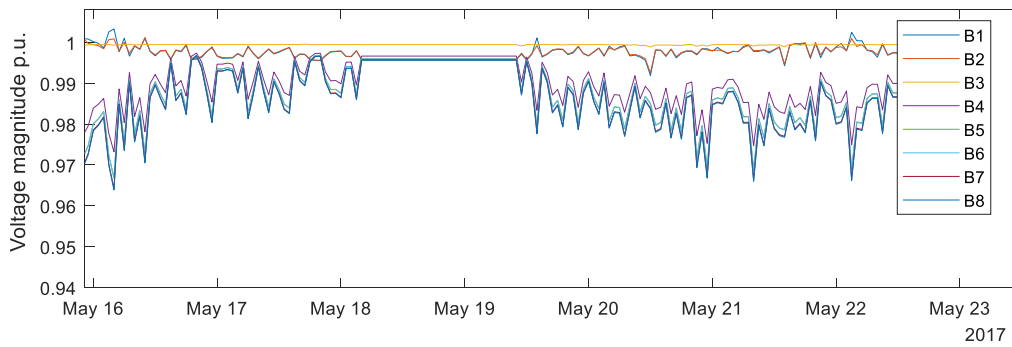

Figure 24 (f): Voltage profiles at various nodes from May 1 – May 22

Figure 24 (b) & 24 (c) show the zoom in version of frequency and electrical demand during May 21, 2017, in order to see the frequency recovery phenomenon after a load increase/decrease. Whenever there is load increase then the frequency tends to fall that can be seen at times 15:19 & 15:21 and if DG should respond for this, its governor takes control action to bring back the frequency to normal by increasing the fuel input, thereby raising the generation. It can be seen from Fig. 24 (d) that there is no production available from both the wind and the solar and, also the energy inside the BESS is zero during 15:19 – 15:24 on May 21-2017 that can be seen in Figure 24 (e), leaving no option other than making DG responsible for primary frequency control. It is to be observed that the optimal fuel consumption case not necessarily helping system frequency to be in limits 49.8-50.2 Hz. The voltage profiles at various nodes (denoted as B1-B8) are shown in Figure 24 (f) where the voltages are well within the operating limits. It is to be observed in Fig. 24 (f) during May 18 & 19, the voltages are nearly constant because there are times where electrical demand data is missing and a dump of 11 kW is only present from the minimum DG production constraint.

Extra case: Comparing measured frequency data with simulation

An additional case is added, where the measured frequency and its corresponding load data from March 2018 are considered. With the measured electrical load, dynamical simulation is carried out for a day in March and the obtained frequency result is compared with that of the practical data as shown in Figures 25 (a), (b) & (c). The measured data is available from 00:00 till 11:00 hrs. in 1 min interval.

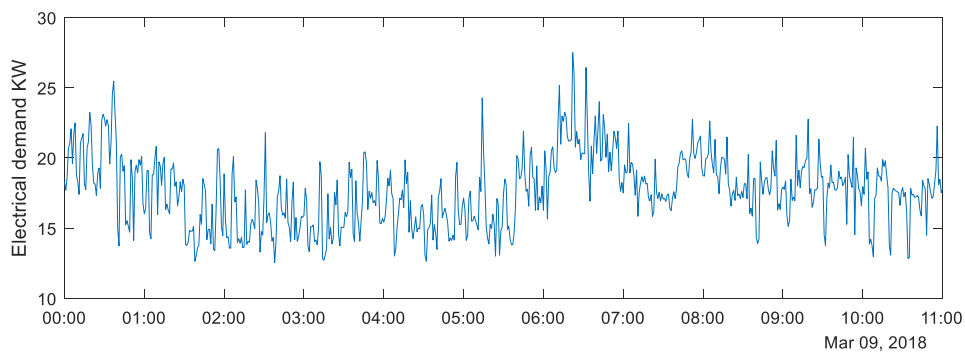

Figure 25 (a): New electrical demand from Mar 9, 2018

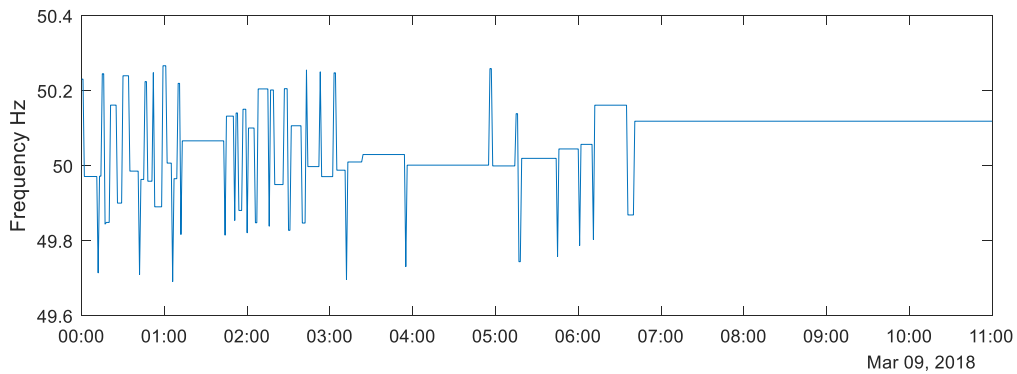

Figure 25 (b): Frequency result from given data with sampling rate 1 min

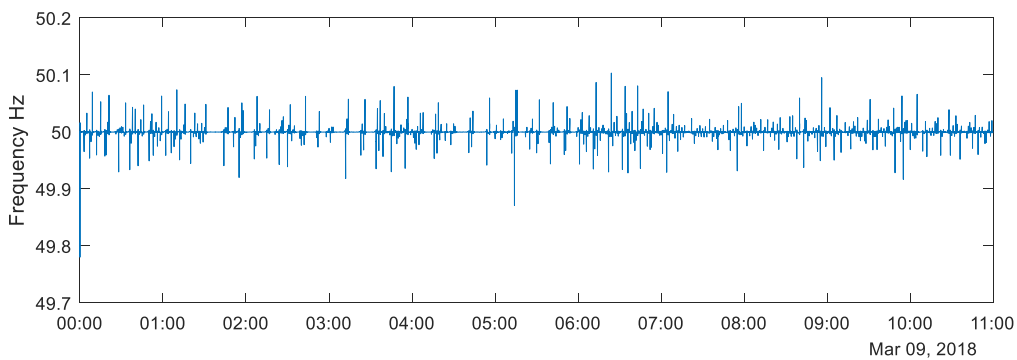

Figure 25 (c): Frequency result from dynamical simulation with sampling rate 0.1 s

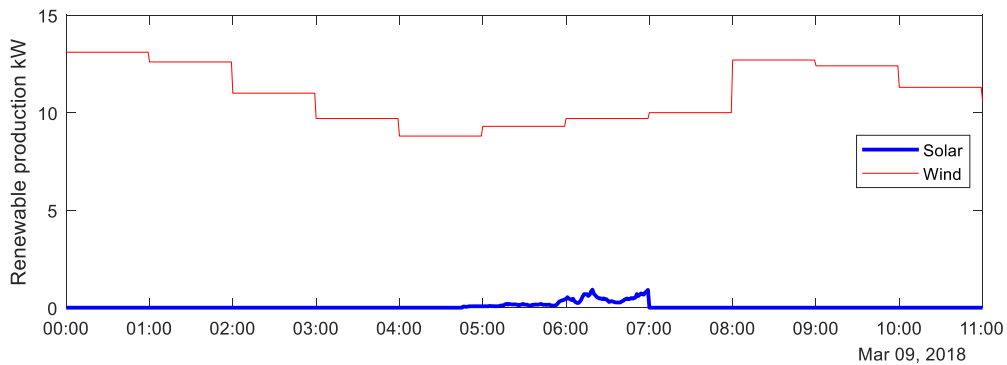

Figure 25 (d): Wind and Solar production on Mar 9, 2018

The sampling rate of the given measured data is 1 min as shown in Figure 25 (b), which could not capture the actual frequency fluctuations. It can be observed from Figs. 25 (b) & 25 (c), the frequency fluctuation responded in same manner after 5 pm, where there is a sudden peak in demand. In the given measured data of frequency, the values are little ambiguous, as at some point after 6 pm, the frequency remained constant irrespective of changes in the electrical demand as shown in Fig. 25 (a). But the simulated results are in line with respect to changes in the electrical demand, however, the magnitude in the overall fluctuations is lesser than that of the result from given measured data. Figure 25 (d) shows the production profiles of wind and solar on Mar 8, 2018. It can be observed that the solar production is almost negligible because of the early morning hours where there is no sun, but there is considerable amount of wind production available.

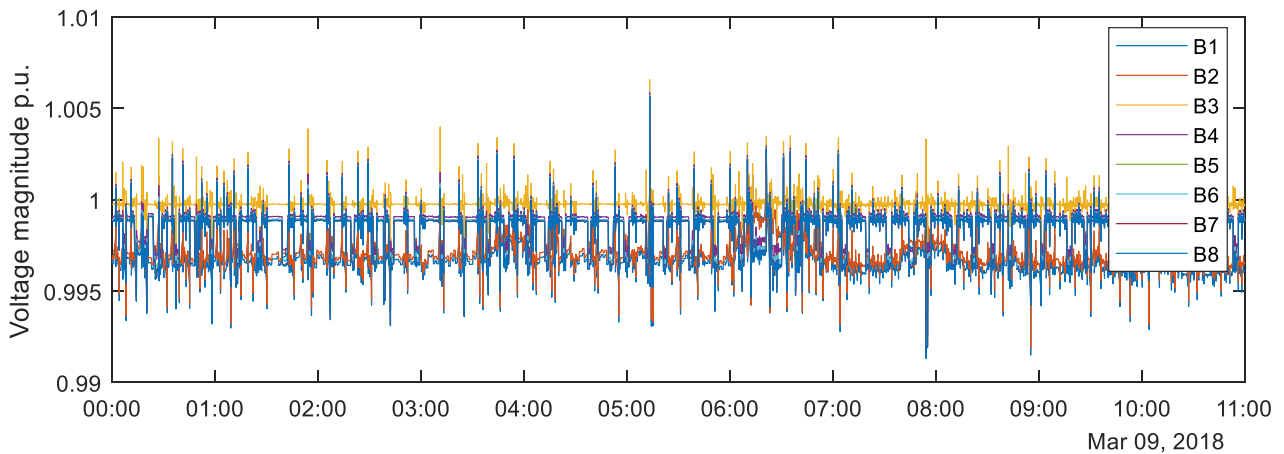

Figure 25 (e): Voltage profile of the grid with renewables for Mar 9, 2018

The voltage profile of the system at various nodes (denoted as B1-B8) is as shown in Figure 25 (e), it can be observed that the voltages are well within the 0.95 – 1.05 p.u. operating limits. It is to be noted that there is no excess energy available during the day for the BESS to store, where the DG is solely responsible for meeting the electrical load.

Conclusions:

The district heating system in the Livø consists of WB with a hot water tank, which is responsible for meeting the thermal demand. In addition, if any gap exists then the large HWST and then OB should follow to fill the gap.

- The interesting fact is that with the effective utilization of excess energy from DG (where electrical demand is less than 11 kW), solar-PV and Wind will lead to the reduced utilization of both the WB and OB in meeting the thermal demand.
- It is worth mentioning here that, the presented results suggest that the considered HWST with heat from not only DG but also from HP and EB that are run by excess from renewables, will certainly meet large of the thermal demand.
- It is also to be noted that there is considerable amount of excess energy that is bypassed from the system in spite some part of it is stored either in BESS as electrical energy or in HWST in the form of heat.
- Moreover, the proposed approach reduces the fuel consumption compared to the base case scenario.
- However, the frequency result from the dynamical simulation suggests that the considered optimal fuel consumption scenario with BESS of 5 kW charge/discharge rating is not fully helping in maintaining the frequency limits 49.8-50.2 Hz (+/- 0.2 Hz). The response rate is < 30 s as specified in [4]. It does not make big difference on the system frequency with and without consideration of response time. The reason can be the inverter rating of BESS is too low for the given system loading to capture its dynamical impact on the frequency. In addition, the available energy in BESS is low most of the time, as the charging is done only if there is any excess after meeting electrical demand including HP and EB.
- The frequency result from the given values and simulated values are compared and are in line with practical result. The droop is considered as 2% in the present simulations.
- There is no voltage problem as such with current operating scenarios.

- Finally, the suggestion is that with further increase in the BESS dispatch capacity, the primary frequency response can be achieved by BESS, thereby the system frequency can be maintained in prescribed limits, also achieving the optimal operation of diesel generator for reducing the fuel consumption.

Research papers:

1. Hierarchical operation of smart loads for minimizing the diesel consumption in a Diesel, Solar and Wind fed Island, to be submitted to Journal, work in progress.
2. BESS based frequency control mechanism in a diesel-PV-Wind Island power system, to be submitted to Journal, work in progress.

References

1. Iker Diaz de Cerio Mendaza, Birgitte Bak-Jensen, Zhe Chen, 'Electric Boiler and Heat Pump Thermo-Electrical Models for Demand Side Management Analysis in Low Voltage Grids,' *International Journal of Smart Grid and Clean Energy*, vol. 2, no. 1, pp. 52–59, January 2013.
2. C. Koch-Ciobotaru, L. Mihet-Popa, F. Isleifsson and H. Bindner, "Simulation model developed for a small-scale PV system in distribution networks," *7th IEEE International Symposium on Applied Computational Intelligence and Informatics (SACI)*, Timisoara, pp. 341-346, 2012.
3. Hyeon-Jin Moon, Jae Won Chang, Seok-Young Lee, Seung-Il Moon, 'Autonomous active power management in isolated microgrid based on proportional and droop control,' *Energy Procedia*, Volume 153, Pages 48-55, 2018.
4. M. M. Hiksas and M. L. Aninditio, "Redox Flow Batteries for small scale energy storage," *IEEE Conference on Technologies for Sustainability (SusTech)*, pp. 134-139, 2016.